

IEC Appliance Inlet C14 with Filter, Fuseholder 1-or 2-pole (5 x 20 mm or 6.3x32 mm, with or without voltage selector (series-parallel)

Standard- or Medical-Filter



Fuse drawer and voltage selector insert must be ordered separately.



Description

- Panel Mount:
Screw-on mounting from front side
- 4 Functions:
Appliance Inlet, Fuseholder with interchangeable fuse drawer for Fuse-links 5 x 20 mm or 6.3 x 32 mm 1- or 2-pole, Voltage Selectors (series-parallel), Line filter in standard and medical version
- Quick connect terminals 4.8 x 0.8 mm

Approvals

- VDE Certificate Number: 40004665 (FKA, FKB)
- UL File Number: E72928 (FKA, FKB)

Characteristics

- All single elements are already partially wired
- For added safety "Extra-Safe" fuse drawers are available
Fuse drawer meets requirements of medical standard IEC/EN 60601-1
The fuse drawer can only be opened with the aid of a tool
The fuseholder is accessible from the equipment front
- Qualified for use in equipment according IEC/EN 60950

References

Alternative: version without line filter [KE](#)

Weblinks

[General Product Information](#), [Approvals](#), [RoHS](#), [CHINA-RoHS](#), [Mating Connectors](#), [e-Store](#), [SCHURTER-Stock-Check](#), [Distributor-Stock-Check](#), [Accessories](#)

Technical Data

Ratings IEC	1 - 10A @ Ta 40 °C / 250VAC; 50Hz
Ratings UL/CSA	1 - 10A @ Ta 40 °C / 125VAC; 60Hz
Leakage Current	standard < 0.5mA (250V / 60Hz) medical < 5 µA (250 V / 60 Hz)
Dielectric Strength	> 1.7kVDC between L-N > 2.7kVDC between L/N-PE Test voltage (2 sec)
Allowable Operation Temp.	-25 °C to 85 °C
Climatic Category	25/085/21 acc. to IEC 60068-1
Degree of Protection	from front side IP 40 acc. to IEC 60529
Protection Class	Suitable for appliances with protection class 1 acc. to IEC 61140
Terminal	Quick connect terminals 4.8 x 0.8 mm
Panel Thickness s	Screw: max 8 mm Mounting screw torque max 0.5 Nm
Material: Housing	Thermoplastic, black, UL 94V-0

Appliance-Inlet/-Outlet	C14 acc. to IEC/EN 60320-1, UL 498, CSA C22.2 no. 42 (for cold conditions) pin-temperature 70 °C, 10A, Protection Class 1
Fuseholder	1 or 2 pole, Shocksafe category PC2 acc. to IEC 60127-6, for fuse-links 5 x 20 or 6.3 x 32 mm
Rated Power Acceptance @ Ta 23 °C	5 x 20: 2.5W (1 pole)/ 2W (2-pole) per pole 6.3 x 32: 3.15W (1 pole)/ 2.5W (2-pole) per pole
Power Acceptance @ Ta > 23°C	Admissible power acceptance at higher ambient temperature see derating curves
Voltage Selectors	series-parallel, 4, 3 or 2 switch positions or usable as 2-pole change-over switch
Line Filter	Standard and Medical Version, IEC 60939, IEC 60601-1, UL 1283, UL 544, EN 133 200, CSA C22.2 no. 8 Technical details
MTBF	> 1'400'000h acc. to MIL-HB-217 F

Dimensions

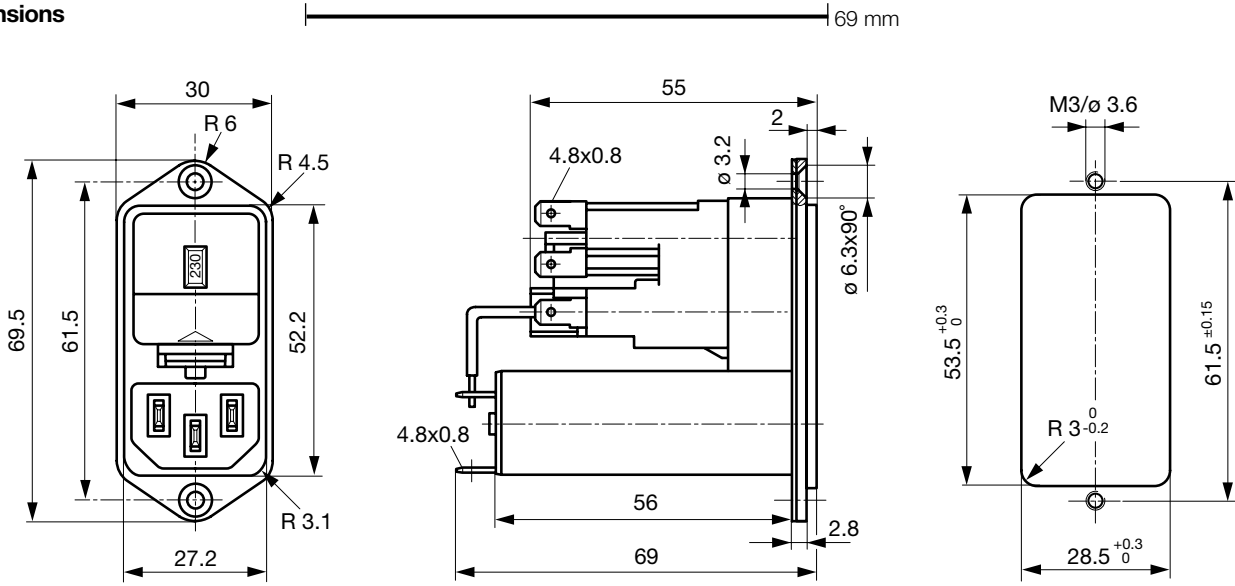

Technical Data of Filter-Components

Rated Current [A]	Filter-Type	Inductances L [mH]	Capacitance CX [nF]	Capacitance CY [nF]	R [MΩ]
1	Standard Version	2 x 10	68	2.2	-
2	Standard Version	2 x 4	68	2.2	-
4	Standard Version	2 x 1.5	68	2.2	-
6	Standard Version	2 x 0.8	68	2.2	-
10	Standard Version	2 x 0.3	68	2.2	-
1	Medical Version (M5)	2 x 10	68	-	1
2	Medical Version (M5)	2 x 4	68	-	1
4	Medical Version (M5)	2 x 1.5	68	-	1
6	Medical Version (M5)	2 x 0.8	68	-	1
10	Medical Version (M5)	2 x 0.3	68	-	1
2	Medical Version (M80)	2 x 4	68	0.47	1

Diagrams

Standard version

Medical version

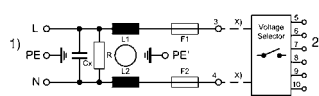
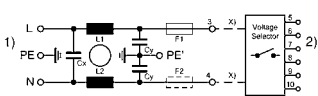

- 1) Line
- 2) Load
- x) External connection to be made by the customer

- 1) Line
- 2) Load
- x) External connection to be made by the customer

Derating Curves

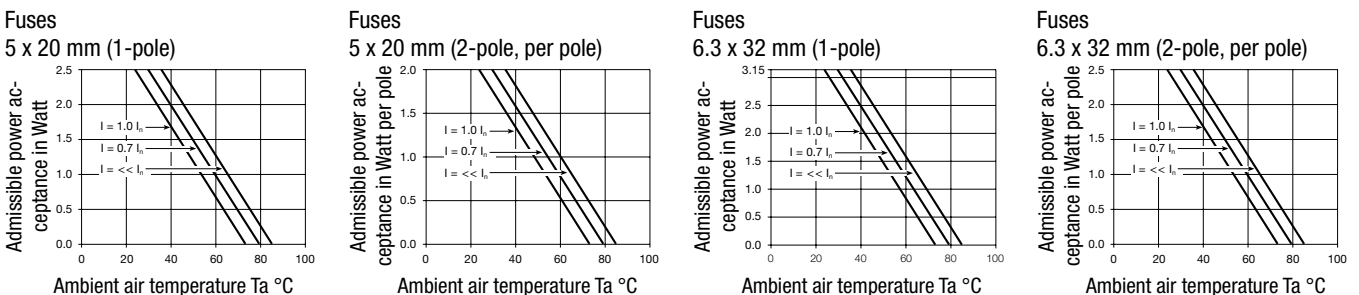

Attenuation Loss 0.1/100Ω differential mode 100/0.1Ω differential mode - - - - differential mode ____ common mode

Standard version

1 A

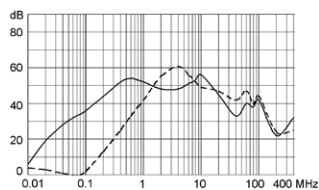

2 A

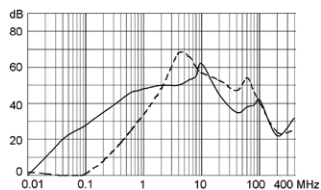

4 A

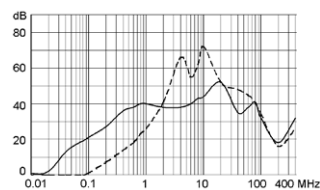

6 A

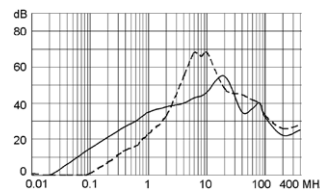

10 A

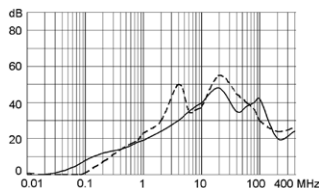

Medical version (M5)

1 A

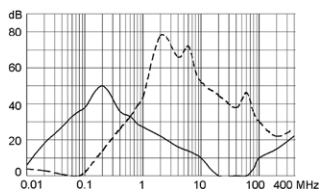

2 A

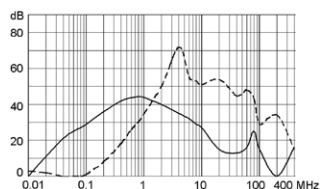

4 A

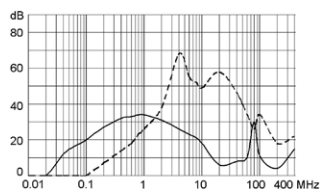

6 A

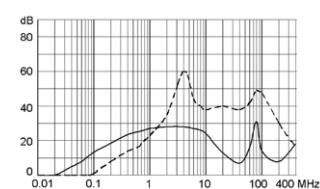

10 A

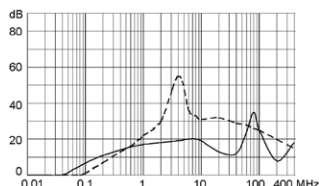

Variants

Fuse drawer and voltage selector insert must be ordered separately.

Rated Current [A]	Filter-Type	Fuseholder	Order Number
1	Standard Version	1-pole	CE16.5100.151
2	Standard Version	1-pole	CE26.5100.151
4	Standard Version	1-pole	CE36.5100.151
6	Standard Version	1-pole	CE45.1100.151
6	Standard Version	1-pole	CE46.5100.151
10	Standard Version	1-pole	CE66.5100.151
1	Standard Version	2-pole	CE10.6100.151
2	Standard Version	2-pole	CE20.6100.151
4	Standard Version	2-pole	CE30.6100.151
6	Standard Version	2-pole	CE40.6100.151
10	Standard Version	2-pole	CE60.6100.151
1	Medical Version (M5)	2-pole	CEG0.6100.151
2	Medical Version (M5)	2-pole	CEA0.6100.151
4	Medical Version (M5)	2-pole	CEC0.6100.151
6	Medical Version (M5)	2-pole	CEE0.6100.151
10	Medical Version (M5)	2-pole	CEL0.6100.151

Rated Current [A]	Filter-Type	Fuseholder	Order Number
2	Medical Version (M80)	2-pole	CEB0.6100.151

Packaging unit 10 Pcs

Required Accessory

Description



Jumper Wire 1
Connection with Stranded Cable

Type A, 70	0881.0074
Type A, 100	0881.0075
Type B, 70	0881.0076
Type B, 100	0881.0077



Fusedrawer 1
Fusedrawer for Fuse Links 5x20mm resp.. 6.3x32mm

5 x 20, 2-pole	4305.0001
5 x 20, 1-pole	4305.0006
6.3 x 32, 2-pole	4305.0011
6.3 x 32, 1-pole	4305.0016

...



Voltage Selectors Insert 1
Voltage Selector Insert to KE, CE, KG, CG

3 or 4 switch positions	4305.0048.00
1, 3 or 4 switch positions, 100, 120, 220, 240	4305.0048.01
3, 3 or 4 switch positions, 130, 110, 240, 220	4305.0048.02
2, 2 switch positions, 110, 220	4305.0048.03

...

Accessories

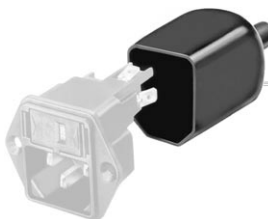

Assorted Covers
Rear Cover

0859.0108



Cord retaining kits
Cord retaining strain relief

Flat head, A	4700.0001
--------------	-----------

Mating Outlets/Connectors

Category / Description



[Appliance Outlet Overview complete](#)

IEC Appliance Outlet F, Screw-on Mounting, Front Side, Solder Terminal	4787
IEC Appliance Outlet F, Snap-in Mounting, Front Side, Solder or Quick-connect Terminal	4788
IEC Appliance Outlet F or H, Screw-on Mounting, Front Side, Solder, PCB or Quick-connect Terminal	5091
IEC Appliance Outlet F or H, Screw-on Mounting, Front Side, Solder or Quick-connect Terminal	5092

[Appliance Outlet further types to CE](#)

[Connector Overview complete](#)



IEC Connector C15, Rewireable, Straight	0101
IEC Connector C15A, Rewireable, Straight	0102
IEC Connector C15A, Rewireable, Straight	0102-G
IEC Connector C15A, Rewireable, Angled	0112
IEC Connector C13, Rewireable, Angled	4012

[Connector further types to CE](#)

...

[Power Cord Overview complete](#)



Power Cord with IEC Connector C13, Angled	0311
Power Cord with IEC Connector C13, Angled	3011
Power Cord with IEC Connector C13, Angled	3012
Power Cord with IEC Connector C13, Angled	3013
Power Cord with IEC Connector C13	3020

[Power Cord further types to CE](#)

...